

DL104

Small Room Hearing Loop Amplifier



USER MANUAL



Table of Contents

Qualified Installer Statement	3
Safety Warnings and Instructions	3
Recycling Instructions	4
Loop Amplifier Overview	5
Main Features	5
Package Contents	6
Controls, Connections, and Adjustments	6
Controls	6
Rear Panel	7
Getting Started: Connecting and Calibrating the Amplifier	7
Rack Mounting and Installation Instructions (Optional)	8
Audio Inputs	8
Power Supply	8
Switching On	8
Loop Integrity	9
Protect and Clip LEDs	9
Setting Up a Simple Perimeter Loop	9
Specifications	10
Certifications	11
CE Certification	11
WEEE Directive: Disposal of Used Electric and Electronic Units	11
RoHS Directive: Compliance with Restrictions	11
Appendices	12
Maintenance and Care	12
Troubleshooting	12
Resources	12
Warranty	13

Qualified Installer Statement

	<p>Implementing the loop path can be difficult. Carefully read the following instructions to ensure proper operation of the system and compliance with the IEC-60118-4 standard.</p>
	<p>Williams AV recommends that this equipment be installed by a person who has taken the Advanced Loop Class.</p> <p>The Williams AV Advanced Loop Class includes specific information about Williams AV Loop Amplifiers in the designing, installing, and commissioning of loop systems.</p>

Safety Warnings and Instructions

WARNING! TO REDUCE THE RISK OF FIRE OR ELECTRIC SHOCK, DO NOT EXPOSE THIS APPLIANCE TO RAIN OR MOISTURE.

CAUTION! TO REDUCE THE RISK OF ELECTRIC SHOCK, DO NOT REMOVE COVER. NO USER-SERVICEABLE PARTS INSIDE. REFER SERVICING TO QUALIFIED SERVICE PERSONNEL.

Important Safety Instructions:

1. Read and follow these instructions.
2. Keep these instructions.
3. Clean only with dry cloth.
4. Do not block any ventilation openings. Install in accordance with the manufacturer's instructions.
5. Do not install near any heat sources such as radiators, heat registers, stoves, or other appliance (including amplifiers) that produce heat.
6. Do not defeat the safety purpose of the polarized or grounding-type plug. A polarized plug has two blades with one wider than the other. A grounding type plug has two blades and a third grounding prong. The wide blade or the third prong is provided for your safety. If the provided plug does not fit into your outlet, consult an electrician for replacement of the obsolete outlet.
7. Protect the power cord from being walked on or pinched particularly at plugs, convenience receptacles, and the point where they exit from the appliance.
8. Only use attachments/accessories specified by the manufacturer.
9. Unplug this appliance during lightning storms or when unused for long periods of time.
10. Power Sources - The appliance should be connected to a power supply only of the type described in the operating instructions or as marked on the appliance.
11. Object and Liquid Entry - Care should be taken so that objects do not fall and liquids are not spilled into the enclosure through the openings. Do not use this appliance near water or expose it to liquids.
12. Servicing - The user should not attempt to service the appliance beyond that described in the operating instructions. All other servicing should be referred to qualified service personnel.

Precautions:

1. Power – WARNING, BEFORE TURNING ON THE POWER FOR THE FIRST TIME, READ THE FOLLOWING SECTION CAREFULLY. The unit is designed for use only with the line cord of the region in which it will be operated.
2. Do Not Plug in the input or output connections while the power switch is switched to the ON position.
3. Do Not Touch the Digi-Loop DL104 with wet hands. Do not handle the Digi-Loop DL104 or power cord when your hands are wet or damp. If water or any other liquid enters the Digi-Loop DL104 cabinet, take the Digi-Loop DL104 to qualified service personnel for inspection.
4. Place the Digi-Loop DL104 in a well ventilated location. Take special care to provide plenty of ventilation on all sides of the Digi-Loop DL104 especially when it is placed in an audio rack. If ventilation is blocked, the Digi-Loop DL104 may over heat and malfunction. Do not expose the Digi-Loop DL104 to direct sun light or heating units as the Digi-Loop DL104 internal components temperature may rise and shorten the life of the components. Avoid damp and dusty places.
5. Care – From time to time you should wipe off the front and side panels and the cabinet with a soft cloth. Do not use rough material, thinners, alcohol or other chemical solvents or cloths since this may damage the finish or remove the panel graphics.

Recycling Instructions

Help Williams AV protect the environment! Please take the time to dispose of your equipment properly.



Product Recycling:

Please do NOT dispose of your equipment in the household trash. Please take the equipment to a electronics recycling center for proper disposal.



Battery Recycling:

Please do NOT dispose of used batteries in the household trash. Please take the batteries to a retail community collection point for recycling.

or

Loop Amplifier Overview

Thank you for purchasing the DL104 Small Room Hearing Loop Amplifier. Williams AV loop amplifiers deliver the latest induction loop technology for inclusion and engagement, providing a high-efficiency Class D amplifier design with support to facilitate their installation and use.

For those unfamiliar with loop systems, please see the Williams AV “Design Guide: Induction Loop Systems” for more information. The guide explains how the induction loop system works, loop types and design, and considerations for sites, cable selection, and installation.

The DL104 allows users to install a single loop in small to medium size areas ranging from 538 ft² to 1,938 ft² (50 m² to 180 m²). Coverage information depends on the configuration of the room and project constraints (e.g., presence of metal structures, overspill, room width). Consider these constraints before installation to comply with IEC-60118-4 requirements.

The DL104 conforms to IEC 62368-1:2018 Benchmark Testing Specifications

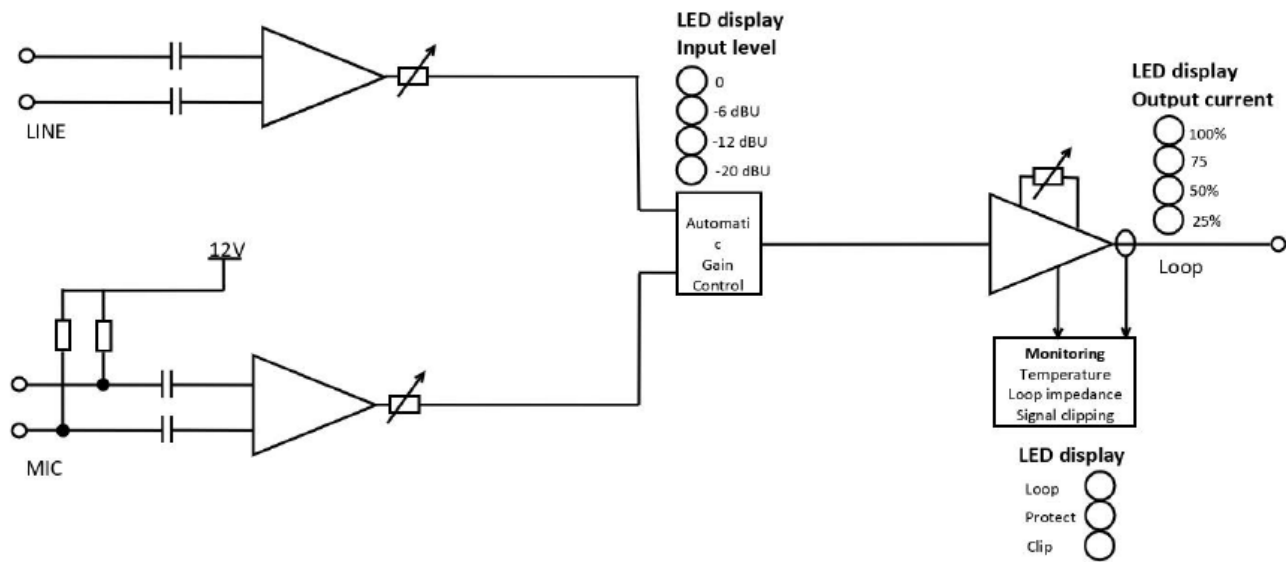

Figure 1. DL104 Indicator circuits

Main Features

The amplifier accepts inputs of analog, mic or line level, balanced or unbalanced.

- Advanced protection circuit helps maintain safe operating temperatures
- Inputs for microphone input or line input, balanced or unbalanced
- Meets CE certifications
- LED indicators
- Peak output current: 8A
- Standby mode
- Active protection against short and open circuits, clipping, and thermal (overheating).
- Meets ADA/ADAAG Guidelines
- 2-year Warranty
- Input level controls
- Loop output level control
- Single unit or dual units mountable in standard 19" rack (with optional rack mount kit)

Package Contents

Upon receipt of your amplifier, check for damages during shipment. Report any damages to your distributor and shipping company, indicating the delivery date, damage type, and whether damages were visible on the packaging before unpacking. If possible, provide the delivery note and tracking numbers.

Your package should include:

- DL104 amplifier
- Black Line Cord
- Set of 3 stickers with the T-coil icon and accompanying text
- Rack mounting kit (optional)

Controls, Connections, and Adjustments

Controls

The amplifier comes with fault detection, allowing you to monitor the unit's main functions, such as power, integrity of the loop cable connected to the amplifier, and inputs.

If any functions are faulty, a red LED on the amplifier's front panel illuminates, and the fault relay opens (NO: Normally Open).

Front Panel

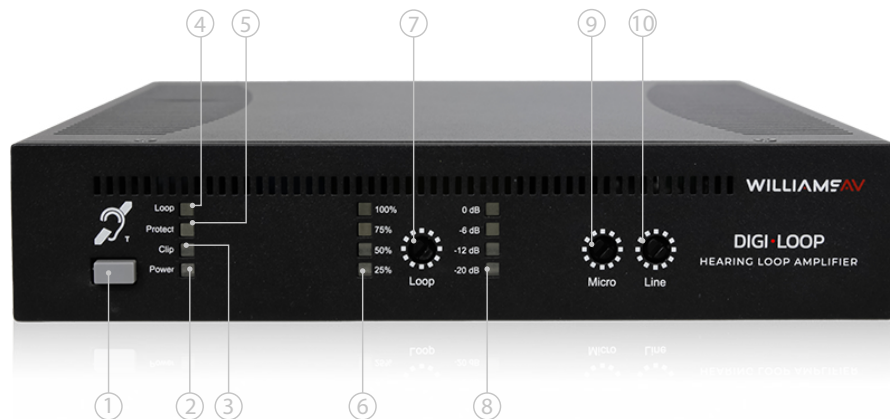

Figure 2. DL104 Front Panel

1. Power On/Sleep push button.
2. "Power" LED indicator.
3. "Clip" LED indicator. This red LED illuminates when the loop amplifier is overloaded, the input level of the loop is too high, or the loop is faulty.
4. "Loop" LED indicator. This green LED illuminates when the loop is in working condition.
5. "Protect" LED light. This red LED illuminates when the loop amplifier is overloaded, the input level of the loop is too high, or the loop is defective.
6. Output signal meter: Indicates the percentage of full current in the induction loop.
7. Output current adjustment screw: Controls the output current to the loop.
8. Input signal meter: Indicates the input signal level after adjustment.

9. Microphone input level adjustment.
10. Line input level adjustment.

Rear Panel



Figure 3. DL104 Rear Panel



11. Line-level input Phoenix-type terminal block: Connects external audio input from a line level source (e.g., mixer, preamp).
12. Microphone-level input Phoenix-type terminal block: Connects external audio input from a microphone (e.g., mixer, preamp).
13. Loop output Phoenix-type terminal block: Connects the loopload (wire) to the amplifier.
14. Power INPUT: line cord connection.

Getting Started: Connecting and Calibrating the Amplifier

The following is a basic overview of the steps needed to use your DL104 amplifier. The goal for installing, testing, and calibrating the amplifier is to meet the IEC specifications for loop systems.

1. Install into the rack (if applicable).
2. Connect the amplifier.
3. Power on the amplifier.
4. Check the loop integrity by observing the "Loop", "Protect" and "Clip" LED indicator lights.
5. Calibrate the amplifier with field strength meter, using a 1 KHz tone and adjusting the loop output current until the meter reads 0dB.

Rack Mounting and Installation Instructions (Optional)

	<p>Burn risk. Provide adequate ventilation for the unit.</p> <p>The DL104 advanced protection circuit allows the amplifier to reduce the output power to maintain safe operating temperatures. Insufficient ventilation may reduce the amplifier output power during normal operation (indicated by the illumination of the red "Clip" and "Protect" LEDs).</p> <p>Keep the space directly above and behind the amplifier clear to reduce the risk of thermal limitation and allow proper heat dissipation. Do not place anything directly on top of the amplifier.</p>
	<p>Rack integration requires the mounting kit.</p>

1. Attach the rack mounting brackets using the mounting screws provided in the optional kit.
2. When mounting a rack with two loop amplifiers, attach the amplifiers to each other with the mounting brackets before installing them into the rack.
3. Leave at least 1U of space above the amplifier.
4. Leave at least 6.6" (168 mm) of space between the bottom of the rack and the amplifier.
5. Use a grounded outlet.
6. Mount the amplifier in the rack.
7. Connect all inputs/outputs before applying power.
8. Plug in the power cord and turn on the unit.

Audio Inputs

Connect audio sources via the inputs in the amplifier. The DL104 has two audio inputs: MIC and LINE.

Power Supply

The DL104 has an integrated power supply of 230V (or 115V), with a power rating of 200VA.

Switching On

Power up the unit using the grey switch on the front of the amplifier. The Power LED illuminates in blue when the amplifier is powered up (Figure 5)

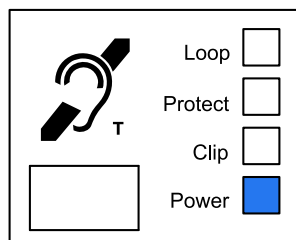
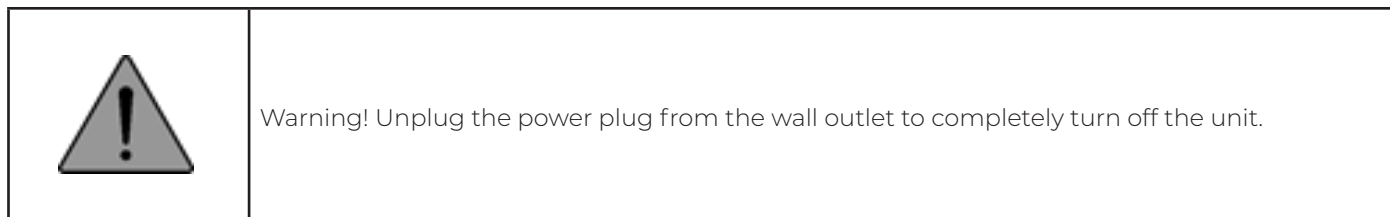

Figure 4. Power on

Press the grey Power switch on the front of the amplifier again to turn the unit off. Note: The unit goes into standby mode when turned off. Unplug the power plug from the wall outlet to completely turn off the unit.



Loop Integrity

Use the green LED on the front of the amplifier to check the loop integrity. If the loop is cut or the loop impedance is outside the range of 0.5-3.0 Ω , the Loop LED will not be displayed, and the Protect LED will illuminate (Figure 5).

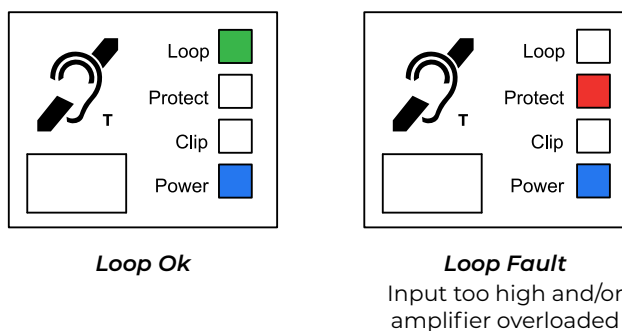



Figure 5. Loop OK vs. Loop Fault

Protect and Clip LEDs

The Protect and Clip LEDs illuminate if:

- The resistance of the inductive loop is not between 0.5 and 3 Ohms.
- The corresponding conductor section is overloaded or overheated.
- The input level is too high, causing clipping of the audio signal.

Setting Up a Simple Perimeter Loop

	<p>Equipment required:</p> <ul style="list-style-type: none"> • Field Strength Meter, such as the Williams AV PLM FSMP. • A physical or electronic copy of the Hearing Loop Field Strength Meter manual, which describes the test procedure. <p>Ensure installation meets the IEC 60118-4 standard.</p>
---	---

1. Press the Power button on the amplifier.
2. Check that all the adjustment screws are at level 0.
3. Connect your loop wire to the Loop terminal block.
4. Connect a 1 kHz sinusoidal source to the Line input.
5. Increase the input signal via the "Line" adjustment screw on the front of the amplifier until you reach between -6 and 0 dB.
6. Increase the output current via the "Loop" adjustment screw on the front panel of the amplifier until you reach between 75% and 85%.
7. Make a first measurement at the center of your room using your FSM.
8. Readjust the "Loop" adjustment screw until you reach -3 dB at the center of the zone.

Specifications

General	
Dimensions	1.7" H x 7.8" W x 8.5" D (42 x 200 x 215 mm)
Weight	3.3 lbs (1.5 kg)
Operating temperature range	32 to 113°F (0 to 45°C)
Storage temperature	-40 to 185°F (-40 to 85°C)
Power Supply	
Type	Integrated
Voltage	115/230 V (automatic) 50/60 Hz
Power (Output)	200VA
Power (Consumption)	6W
Nominal power consumption at 1 Ohm	50W
Maximum input power	500VA
Power Consumption at rest with connected loop	14W at 230V AC, 2 loop of 1 Ohm connected, at ambient temperature after 30 minutes of stabilization.
Input	
Line-In Audio	(1x) 3-position terminal block (Phoenix)
Microphone (100V)	(1x) 3-position terminal block (Phoenix)
Power supply	12V 2mA
Sensitivity	-50dB micro, +40dB 100V, -10dB line
Output	
Loop impedance	0.5 - 3.0 Ω
Output voltage	34 Vrms (48 Vpk)
Peak current	8A
RMS current	4 Arms
Loop Out	(1x) 2-position terminal block (Phoenix)
Audio Characteristics	
Bandwidth	80 Hz to 9.5 kHz
Additional Functions	
LED display	LED "Protect" light
Checking (synthesis fault)	DC current too high – Open loop – Thermal protection
Cooling	Natural cooling
IP rating	IP 20
Frequency response	40 Hz to 9.0 kHz



Specifications are subject to change. Visit the Williams AV website for the latest specifications: <https://williamsav.com>.

Certifications

CE Certification

The DL104 complies with the following CE directives:

- 2017 / 2102 / CE RoHS-directive
- 2012 / 19 / CE WEEE-directive
- 2014 / 35 / CE Low voltage directive
- 2014 / 30 / CE Electromagnetic Compatibility

Compliance with the directives listed above is confirmed by the CE seal on the device.



WEEE Directive: Disposal of Used Electric and Electronic Units

This symbol indicates the product should not be handled as ordinary household waste. Return to a collecting point for recycling electric and electronic units.

Disposing of this product correctly impacts the environment and people's health. Also, material recycling helps reduce the consumption of raw materials.

Community organizations, disposal companies, or resellers will provide more information on recycling this product.

RoHS Directive: Compliance with Restrictions

Substances used in the DL104 also comply with the E.U. Restriction of Hazardous Substances Directive (RoHS) in

electrical and electronic equipment.



	Applicable in European Union member states or other European countries with a separate collection (disposal) system.
---	--

Appendices

Maintenance and Care

The DL104 does not require any maintenance. If the unit becomes dirty, simply wipe it clean with a soft, damp cloth.

Store the device in a dry place, protected from dust when not in use.

	Disconnect the DL104 amplifier from the power supply before wiping it clean. Never use spirits, thinners, or other organic solvents on the DL104. The DL104 is not protected against splash water. Do not place containers filled with water, such as flower vases, or anything with an open flame, such as a lit candle, on or near the product.
	Do not place the DL104 where it will be exposed to full sun for long periods. Protect against excessive heat, moisture, and severe mechanical shocks.

Troubleshooting

Do not service the amplifier. Contact Williams AV Customer Service for assistance at 1.800.843.3544 (U.S.A.) or +1 952.943.2252 (outside the U.S.A.).

Resources

- Download Manuals, Specifications, and Loop Certification Forms from [our website](#).
- Loop System Designs are provided at no charge to authorized dealers, distributors, or integrators who have specific projects with signed contracts. Our Tech Blue Department creates these designs upon

receiving the design request form and architectural plans. This form can be found at: <https://williamsav.com/hearing-loop-design-request/>.

- Technical Support is provided by our Tech Blue Department from 8:00 am to 4:30 pm Central Time. You can reach us by calling 800.328.6190 (ask for Tech Blue) or emailing Tech.Blue@williamsav.com.
- Review our [Hearing Loop Design Guide](#) for more information on installing your induction loop system.

Warranty

Williams AV products, a brand owned by Williams AV, are engineered, designed, and manufactured under carefully controlled conditions to provide you with many years of reliable service.

Williams AV warrants the DL104 Small Room Hearing Loop Amplifier against defects in materials and workmanship under normal use and conditions for 2 years from date of purchase if the completed warranty card is filled out and accompanied by the dealer's invoice or receipt.

This warranty is available to the original end purchaser of the product and CAN BE transferred to subsequent purchasers of the product.

Microphones, earphones, headphones, batteries, chargers, cables, carry cases, and most other accessory products carry a 90-day warranty.

Williams AV has no control over the conditions under which this product is used. Williams AV, therefore, disclaims all warranties not set forth above, both express and implied, with respect to the DL104 Small Room Hearing Loop Amplifier, including but not limited to, any implied warranty of merchantability or fitness of use of such equipment including, without limitation, any warranty that the use of such equipment for any purpose will comply with applicable laws and regulations. Williams AV shall not be liable to any person or entity for any medical expenses or any direct, incidental or consequential damages caused by any use, defect, failure or malfunctioning of the product, whether a claim for such damages is based upon warranty, contract, tort or otherwise, the sole remedy for any defect, failure or malfunction of the products is replacement of the product. No person has any authority to bind Williams AV to any representation or warranty with respect to the DL104 Small Room Hearing Loop Amplifier. Unauthorized repairs or modifications will void the warranty. This warranty is void if damage occurred because of misuse, or if the product has been repaired or modified by anyone other than a factory authorized service technician. Warranty does not cover normal wear and tear on the product or any other physical damage unless the damage was the result of a manufacturing defect. Williams AV is not liable for consequential damages due to any failure of equipment to perform as intended. Williams AV shall bear no responsibility or obligation with respect to the manner of use of any equipment sold by it.

This warranty does not cover reimbursement for your costs of removing and transporting the product for warranty service evaluation or installation of any replacement product provided under this warranty.

The exclusions and limitations set out above are not intended to, and should not be construed so as to contravene mandatory provisions of applicable law. If any part or term of this Disclaimer of Warranty is held to be illegal, unenforceable, or in conflict with applicable law by a court of competent jurisdiction, the validity of the remaining portions of this Disclaimer of Warranty shall not be affected, and all rights and obligations shall be construed and enforced as if this Limited Warranty did not contain the particular part or term held to be invalid. The terms of the warranty are governed by the laws of the State of Minnesota.

Prices and the specifications of the products are subject to change without notice.

For Complete Warranty Statement go to: www.williamsav.com/warranty-statement

NOTICE: Williams AV products are NOT designed for use in extreme temperature, humidity or chemical environments. The introduction of chemicals such as chlorine, salt water or human sweat into the product will cause damage to the circuitry. Damage due to these causes is NOT covered under the Product Warranty.

If you experience difficulty with your system, call Toll-Free for Customer Assistance 1-800-843-3544 (U.S.A.) or +1 952 943 2252 (Outside the U.S.A.)

If it is necessary to return the system for service, your Customer Service Representative will give you a Return Authorization Number (RA) and shipping instructions.

This page intentionally left blank.